



H O S E F I T T I N G S



ООО «ТИ-СИСТЕМС» ИНЖИНИРИНГ И ПОСТАВКА ТЕХНОЛОГИЧЕСКОГО ОБОРУДОВАНИЯ
Интернет: www.tisys.ru www.tisys.kz www.tisys.by www.tesec.ru www.ti-sistems.pf
Телефоны: +7 (495) 7774788, 7489626, (925) 5007155, 54, 65
Эл. почта: info@tisys.ru info@tisys.kz info@tisys.by

HOSE FITTINGS

List of Major Third Party Inspection Agencies



List of Major Consumers

REFINERIES

STEEL INDUSTRIES

CONSULTANTS

CHEMICAL INDUSTRIES

PHARMACEUTICALS

FERTILIZERS

FOOD AND PAINT INDUSTRIES

TANK FARMS

THERMAL POWER STATIONS

AEROSPACE INDUSTRIES

DEFENCE INDUSTRIES

NUCLEAR POWER CORPORATION

ATOMIC ENERGY

SHIPPING INDUSTRIES

OIL & NATURAL GAS COMMISSION

CONSTRUCTION & ENGINEERING INDUSTRIES



Certificates of Registration

ISO 9001:2015

CE MARKING (97/23/EC-PED)

ATEX (2014/34/EU)

ISO 14001:2015

OHSAS 18001:2007

ООО «ТИ-СИСТЕМС» ИНЖИНИРИНГ И ПОСТАВКА ТЕХНОЛОГИЧЕСКОГО ОБОРУДОВАНИЯ

Интернет: www.tisys.ru www.tisys.kz www.tisys.by www.tesec.ru www.ti-sistems.by

Телефоны: +7 (495) 7774788, 7489626, (925) 5007155, 54, 65

Эл. почта: info@tisys.ru info@tisys.kz info@tisys.by

INDEX

1-3



CAMLOCK COUPLINGS

4



UNIVERSAL TYPE FITTINGS-CLAW COUPLINGS

5-6



QUICK RELEASE COUPLINGS - VV

7-8



QUICK RELEASE COUPLINGS - V

9-10



QUICK RELEASE COUPLINGS - T

11



COMPOSITE HOSE FITTINGS

12



STANDARD HOSE FITTINGS

HOSE FITTINGS

CAMLOCK COUPLINGS

Manufacturing Standard: In Accordance to EN 14420-7:2013

TYPE		1"	2"	3"	4"	6"	MOC
 TYPE A - ADAPTOR FEMALE THREAD (BSP/NPT)	PART NO.	25-A-C	50-A-C	80-A-C	100-A-C	150-A-C	CARBON STEEL
	PART NO.	25-A-A	50-A-A	80-A-A	100-A-A	150-A-A	ALUMINIUM
	PART NO.	25-A-S4	50-A-S4	80-A-S4	100-A-S4	150-A-S4	SS304
	PART NO.	25-A-S6	50-A-S6	80-A-S6	100-A-S6	150-A-S6	SS316
 TYPT F - ADAPTOR MALE THREAD (BSP/NPT)	PART NO.	25-F-C	50-F-C	80-F-C	100-F-C	150-F-C	CARBON STEEL
	PART NO.	25-F-A	50-F-A	80-F-A	100-F-A	150-F-A	ALUMINIUM
	PART NO.	25-F-S4	50-F-S4	80-F-S4	100-F-S4	150-F-S4	SS304
	PART NO.	25-F-S6	50-F-S6	80-F-S6	100-F-S6	150-F-S6	SS316
 TYPE E - ADAPTOR WITH HOSE SHANK	PART NO.	25-E-C	50-E-C	80-E-C	100-E-C	150-E-C	CARBON STEEL
	PART NO.	25-E-A	50-E-A	80-E-A	100-E-A	150-E-A	ALUMINIUM
	PART NO.	25-E-S4	50-E-S4	80-E-S4	100-E-S4	150-E-S4	SS304
	PART NO.	25-E-S6	50-E-S6	80-E-S6	100-E-S6	150-E-S6	SS316
 TYPE AWF - ADAPTOR FOR BUTT WELD	PART NO.	25-AWF-C	50-AWF-C	80-AWF-C	100-AWF-C	150-AWF-C	CARBON STEEL
	PART NO.	25-AWF-A	50-AWF-A	80-AWF-A	100-AWF-A	150-AWF-A	ALUMINIUM
	PART NO.	25-AWF-S4	50-AWF-S4	80-AWF-S4	100-AWF-S4	150-AWF-S4	SS304
	PART NO.	25-AWF-S6	50-AWF-S6	80-AWF-S6	100-AWF-S6	150-AWF-S6	SS316
 TYPE AWA - ADAPTOR FOR SOCKET WELD	PART NO.	25-AWA-C	50-AWA-C	80AWA-C	100-AWA-C	150-AWA-C	CARBON STEEL
	PART NO.	25-AWA-A	50-AWA-A	80-AWA-A	100-AWA-A	150-AWA-A	ALUMINIUM
	PART NO.	25-AWA-S4	50-AWA-S4	80-AWA-S4	100-AWA-S4	150-AWA-S4	SS304
	PART NO.	25-AWA-S6	50-AWA-S6	80-AWA-S6	100-AWA-S6	150-AWA-S6	SS316

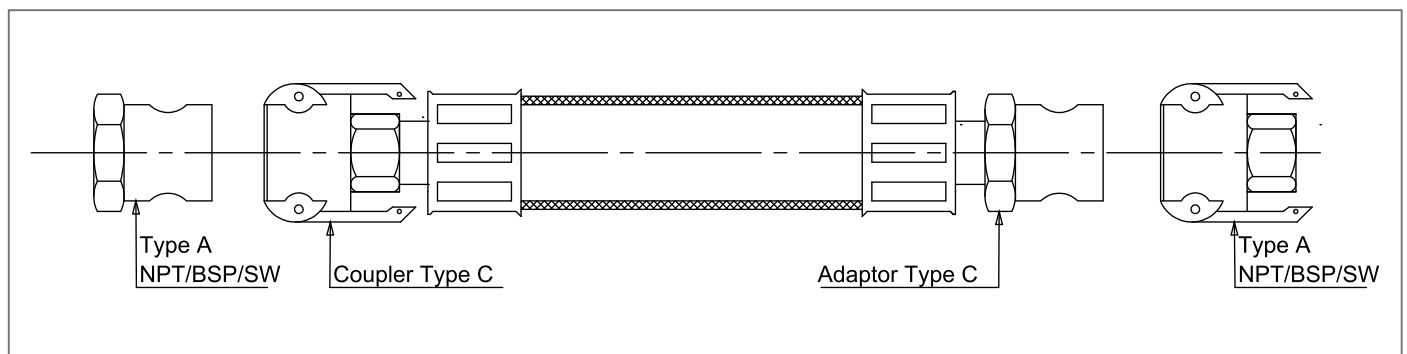

ООО «ТИ-СИСТЕМС» ИНЖИНИРИНГ И ПОСТАВКА ТЕХНОЛОГИЧЕСКОГО ОБОРУДОВАНИЯ





Интернет: www.tisys.ru www.tisys.kz www.tisys.by www.tesec.ru www.ти-системс.рф

Телефоны: +7 (495) 7774788, 7489626, (925) 5007155, 54, 65

Эл. почта: info@tisys.ru info@tisys.kz info@tisys.by

CAMLOCK COUPLINGS

Manufacturing Standard: In Accordance to EN 14420-7:2013

TYPE		1"	2"	3"	4"	6"	MOC
 TYPE DP - MALE DUST PLUG	PART NO.	25-DP-C	50-DP-C	80-DP-C	100-DP-C	150-DP-C	CARBON STEEL
	PART NO.	25-DP-A	50-DP-A	80-DP-A	100-DP-A	150-DP-A	ALUMINIUM
	PART NO.	25-DP-S4	50-DP-S4	80-DP-S4	100-DP-S4	150-DP-S4	SS304
	PART NO.	25-DP-S6	50-DP-S6	80-DP-S6	100-DP-S6	150-DP-S6	SS316
 TYPE FA - ADAPTOR WITH FLANGE	PART NO.	25-FA-C	50-FA-C	80-FA-C	100-FA-C	150-FA-C	CARBON STEEL
	PART NO.	25-FA-A	50-FA-A	80-FA-A	100-FA-A	150-FA-A	ALUMINIUM
	PART NO.	25-FA-S4	50-FA-S4	80-FA-S4	100-FA-S4	150-FA-S4	SS304
	PART NO.	25-FA-S6	50-FA-S6	80-FA-S6	100-FA-S6	150-FA-S6	SS316
 TYPE D - COUPLER FEMALE THREAD (BSP/NPT)	PART NO.	25-D-C	50-D-C	80-D-C	100-D-C	150-D-C	CARBON STEEL
	PART NO.	25-D-A	50-D-A	80-D-A	100-D-A	150-D-A	ALUMINIUM
	PART NO.	25-D-S4	50-D-S4	80-D-S4	100-D-S4	150-D-S4	SS304
	PART NO.	25-D-S6	50-D-S6	80-D-S6	100-D-S6	150-D-S6	SS316
 TYPE B - COUPLER MALE THREAD (BSP/NPT)	PART NO.	25-B-C	50-B-C	80-B-C	100-B-C	150-B-C	CARBON STEEL
	PART NO.	25-B-A	50-B-A	80-B-A	100-B-A	150-B-A	ALUMINIUM
	PART NO.	25-B-S4	50-B-S4	80-B-S4	100-B-S4	150-B-S4	SS304
	PART NO.	25-B-S6	50-B-S6	80-B-S6	100-B-S6	150-B-S6	SS316
 TYPE C - COUPLER WITH HOSE SHANK	PART NO.	25-C-C	50-C-C	80-C-C	100-C-C	150-C-C	CARBON STEEL
	PART NO.	25-C-A	50-C-A	80-C-A	100-C-A	150-C-A	ALUMINIUM
	PART NO.	25-C-S4	50-C-S4	80-C-S4	100-C-S4	150-C-S4	SS304
	PART NO.	25-C-S6	50-C-S6	80-C-S6	100-C-S6	150-C-S6	SS316

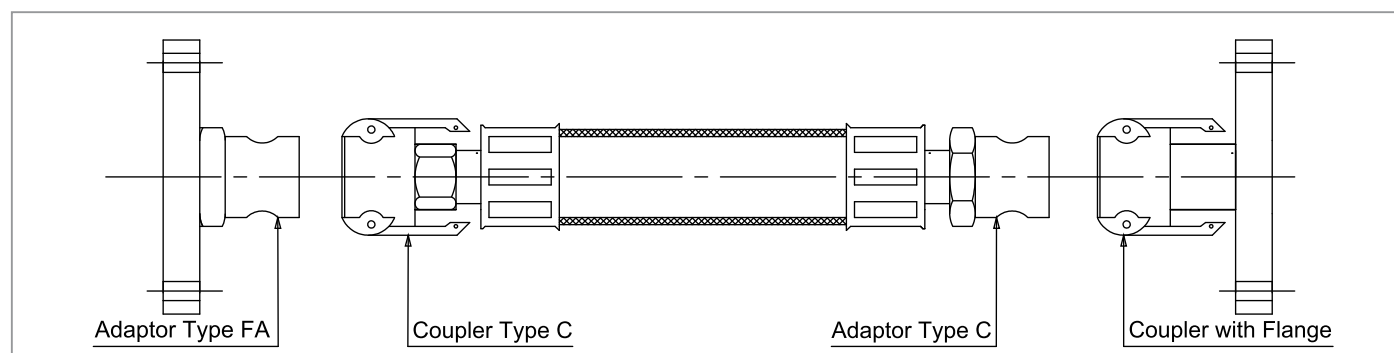

ООО «ТИ-СИСТЕМС» ИНЖИНИРИНГ И ПОСТАВКА ТЕХНОЛОГИЧЕСКОГО ОБОРУДОВАНИЯ

Интернет: www.tisys.ru www.tisys.kz www.tisys.by www.tesec.ru www.ti-sistemc.pф

Телефоны: +7 (495) 7774788, 7489626, (925) 5007155, 54, 65







Эл. почта: info@tisys.ru info@tisys.kz info@tisys.by

JRE PVT LTD.

02

CAMLOCK COUPLINGS

Manufacturing Standard: In Accordance to EN 14420-7:2013

TYPE		1"	2"	3"	4"	6"	MOC
 <p>TYPE DWB - COUPLER FOR BUTT WELD</p>	PART NO.	25-DWB-C	50-DWB-C	80-DWB-C	100-DWB-C	150-DWB-C	CARBON STEEL
	PART NO.	25-DWB-A	50-DWB-A	80-DWB-A	100-DWB-A	150-DWB-A	ALUMINIUM
	PART NO.	25-DWB-S4	50-DWB-S4	80-DWB-S4	100-DWB-S4	150-DWB-S4	SS304
	PART NO.	25-DWB-S6	50-DWB-S6	80-DWB-S6	100-DWB-S6	150-DWB-S6	SS316
 <p>TYPE DWD - COUPLER FOR SOCKET WELD</p>	PART NO.	25-DWD-C	50-DWD-C	80-DWD-C	100-DWD-C	150-DWD-C	CARBON STEEL
	PART NO.	25-DWD-A	50-DWD-A	80-DWD-A	100-DWD-A	150-DWD-A	ALUMINIUM
	PART NO.	25-DWD-S4	50-DWD-S4	80-DWD-S4	100-DWD-S4	150-DWD-S4	SS304
	PART NO.	25-DWD-S6	50-DWD-S6	80-DWD-S6	100-DWD-S6	150-DWD-S6	SS316
 <p>TYPE DC - FEMALE DUST CAP</p>	PART NO.	25-DC-C	50-DC-C	80-DC-C	100-DC-C	150-DC-C	CARBON STEEL
	PART NO.	25-DC-A	50-DC-A	80-DC-A	100-DC-A	150-DC-A	ALUMINIUM
	PART NO.	25-DC-S4	50-DC-S4	80-DC-S4	100-DC-S4	150-DC-S4	SS304
	PART NO.	25-DC-S6	50-DC-S6	80-DC-S6	100-DC-S6	150-DC-S6	SS316
 <p>TYPE FC - COUPLER WITH FLANGE</p>	PART NO.	25-FC-C	50-FC-C	80-FC-C	100-FC-C	150-FC-C	CARBON STEEL
	PART NO.	25-FC-A	50-FC-A	80-FC-A	100-FC-A	150-FC-A	ALUMINIUM
	PART NO.	25-FC-S4	50-FC-S4	80-FC-S4	100-FC-S4	150-FC-S4	SS304
	PART NO.	25-FC-S6	50-FC-S6	80-FC-S6	100-FC-S6	150-FC-S6	SS316
 <p>RING/CHAIN</p>  <p>R TYPE SAFETY CLIP</p>	PART NO.	C-JRE-SS					STAINLESS STEEL
	PART NO.	SC- JRE-SS					STAINLESS STEEL

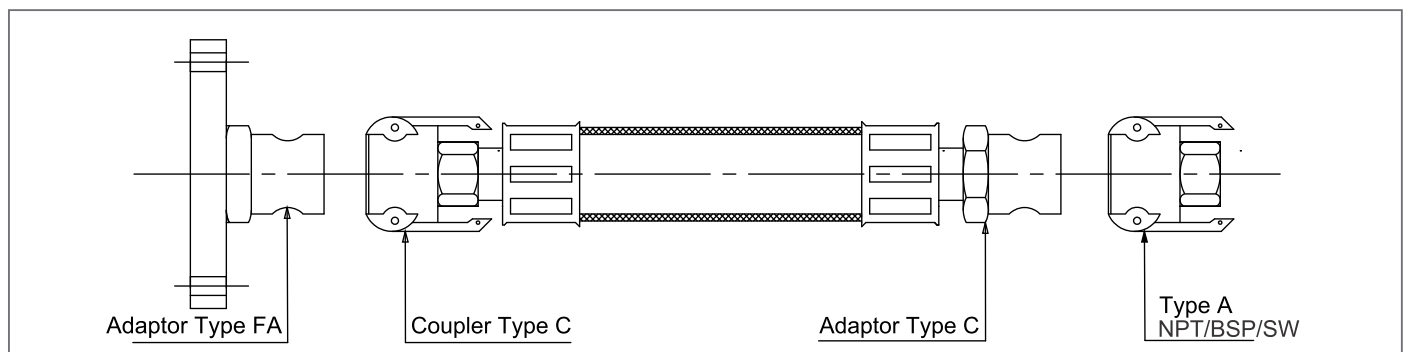

ООО «ТИ-СИСТЕМС» ИНЖИНИРИНГ И ПОСТАВКА ТЕХНОЛОГИЧЕСКОГО ОБОРУДОВАНИЯ

Интернет: www.tisys.ru www.tisys.kz www.tisys.by www.tesec.ru www.ти-системс.рф

Телефоны: +7 (495) 7774788, 7489626, (925) 5007155, 54, 65

Эл. почта: info@tisys.ru info@tisys.kz info@tisys.by

UNIVERSAL TYPE FITTINGS (CLAW COUPLINGS)

TYPE		1/2"	3/4"	1"	MOC
 HOSE END	PART NO	AM-AWM1	AM-AWM6	AM-AWM11	MALLEABLE IRON
	PART NO	AM-AWC1	AM-AWC6	AM-AWC11	CARBON STEEL
 MALE END	PART NO	AM-AWM2	AM-AWM7	AM-AWM12	MALLEABLE IRON
	PART NO	AM-AWC2	AM-AWC7	AM-AWC12	CARBON STEEL
 FEMALE END	PART NO	AM-AWM3	AM-AWM8	AM-AWM13	MALLEABLE IRON
	PART NO	AM-AWC3	AM-AWC8	AM-AWC13	CARBON STEEL
 BLIND END	PART NO	AMO-AWM			MALLEABLE IRON
	PART NO	AMO-AWC			CARBON STEEL
 PT CLAMP	PART NO	A-AWM31	A-AWM32	A-AWM33	MALLEABLE IRON
	PART NO	A-AWC31	A-AWC32	A-AWC33	CARBON STEEL
 CLAMP- TWO BOLT- TWO GRIP	PART NO	A-AWM4	A-AWM9	A-AWM10	MALLEABLE IRON
	PART NO	A-AWC4	A-AWC9	A-AWC10	CARBON STEEL

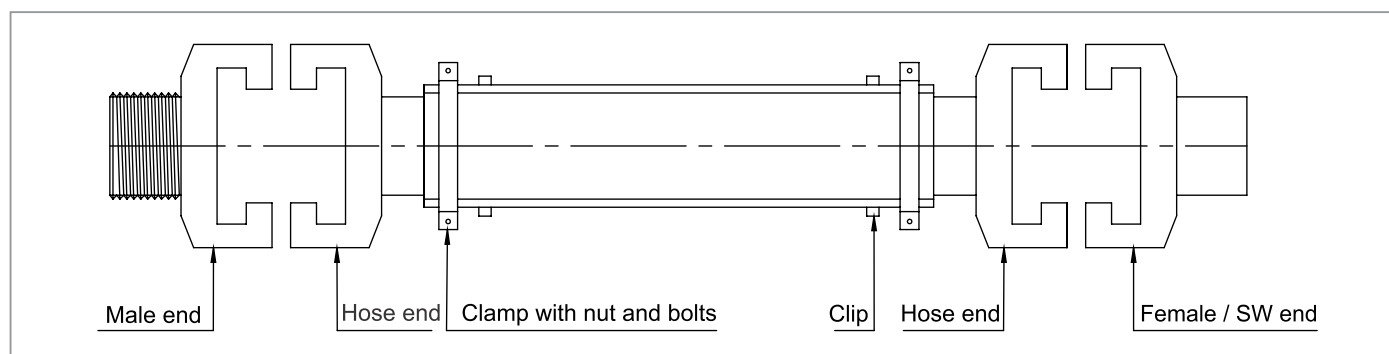

QUICK RELEASE COUPLINGS - VV

Manufacturing Standard: In Accordance to ISO 7241:2014

IMAGE	PART NO.	SIZE	MOC	ENDS	PR. PSI
 <p>COUPLER WITH NRV</p>	6VVC 6VCA	1/4"	CARBON STEEL	BSP/NPT-(M/F)/FLANGED/ SOCKET WELD	5075
	6VVS4C 6VVS4A	1/4"	SS304	BSP/NPT-(M/F)/FLANGED/ SOCKET WELD	5075
	6VVCB 6VVCBA	1/4"	BRASS	BSP/NPT-(M/F)/FLANGED/ SOCKET WELD	5075
	6VVS6C 6VVS6A	1/4"	SS316	BSP/NPT-(M/F)/FLANGED/ SOCKET WELD	5075
 <p>ADAPTOR WITH NRV</p>	10VVC 10VCA	3/8"	CARBON STEEL	BSP/NPT-(M/F)/FLANGED/ SOCKET WELD	4350
	10VVS4C 10VVS4A	3/8"	SS304	BSP/NPT-(M/F)/FLANGED/ SOCKET WELD	4350
	10VVCB 10VVCBA	3/8"	BRASS	BSP/NPT-(M/F)/FLANGED/ SOCKET WELD	4350
	10VVS6C 10VVS6A	3/8"	SS316	BSP/NPT-(M/F)/FLANGED/ SOCKET WELD	4350
 <p>ASSEMBLY VV TYPE</p>	12VVC 12VCA	1/2"	CARBON STEEL	BSP/NPT-(M/F)/FLANGED/ SOCKET WELD	4350
	12VVS4C 12VVS4A	1/2"	SS304	BSP/NPT-(M/F)/FLANGED/ SOCKET WELD	4350
	12VVCB 12VVCBA	1/2"	BRASS	BSP/NPT-(M/F)/FLANGED/ SOCKET WELD	4350
	12VVS6C 12VVS6A	1/2"	SS316	BSP/NPT-(M/F)/FLANGED/ SOCKET WELD	4350

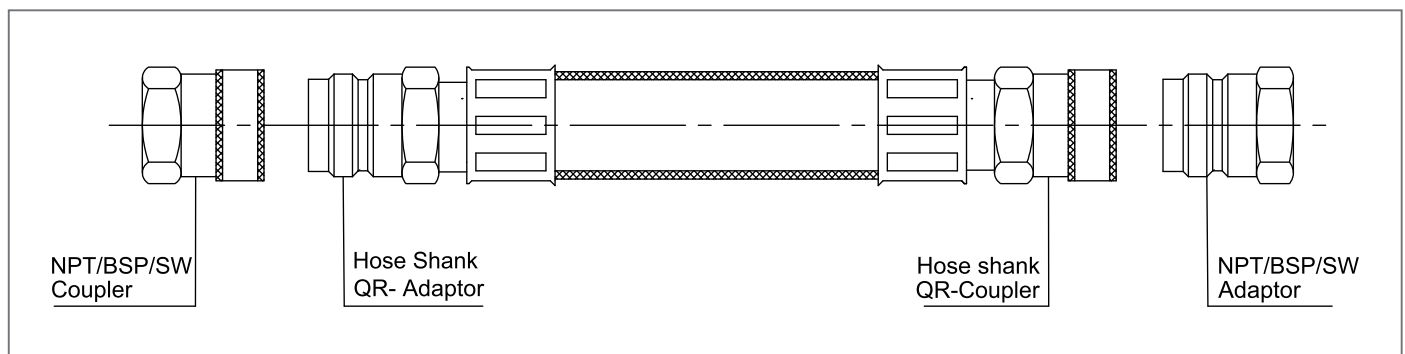

ООО «ТИ-СИСТЕМС» ИНЖИНИРИНГ И ПОСТАВКА ТЕХНОЛОГИЧЕСКОГО ОБОРУДОВАНИЯ

Интернет: www.tisys.ru www.tisys.kz www.tisys.by www.tesec.ru www.ти-системс.рф

Телефоны: +7 (495) 7774788, 7489626, (925) 5007155, 54, 65

Эл. почта: info@tisys.ru info@tisys.kz info@tisys.by

QUICK RELEASE COUPLINGS - VV

Manufacturing Standard: In Accordance to ISO 7241:2014

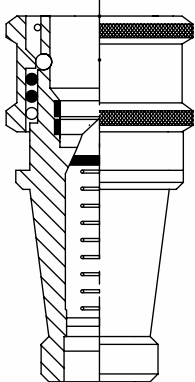
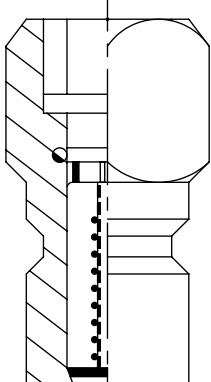
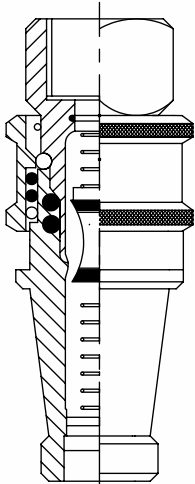
IMAGE	PART NO.	SIZE	MOC	ENDS	PR. PSI
 <p>COUPLER WITH NRV</p>	20VCC 20VCA	3/4"	CARBON STEEL	BSP/NPT-(M/F)/FLANGED/ SOCKET WELD	3625
	20VVS4C 20VVS4A	3/4"	SS304	BSP/NPT-(M/F)/FLANGED/ SOCKET WELD	3625
	20VBC 20VBBA	3/4"	BRASS	BSP/NPT-(M/F)/FLANGED/ SOCKET WELD	3625
	20VVS6C 20VVS6A	3/4"	SS316	BSP/NPT-(M/F)/FLANGED/ SOCKET WELD	3625
	25VCC 25VCA	1"	CARBON STEEL	BSP/NPT-(M/F)/FLANGED/ SOCKET WELD	3000
 <p>ADAPTOR WITH NRV</p>	25VVS4C 25VVS4A	1"	SS304	BSP/NPT-(M/F)/FLANGED/ SOCKET WELD	3000
	25VBC 25VBBA	1"	BRASS	BSP/NPT-(M/F)/FLANGED/ SOCKET WELD	3000
	25VVS6C 25VVS6A	1"	SS316	BSP/NPT-(M/F)/FLANGED/ SOCKET WELD	3000
	32VCC 32VCA	1-1/4"	CARBON STEEL	BSP/NPT-(M/F)/FLANGED/ SOCKET WELD	3000
	32VVS4C 32VVS4A	1-1/4"	SS304	BSP/NPT-(M/F)/FLANGED/ SOCKET WELD	3000
 <p>ASSEMBLY VV TYPE</p>	32VBC 32VBBA	1-1/4"	BRASS	BSP/NPT-(M/F)/FLANGED/ SOCKET WELD	3000
	32VVS6C 32VVS6A	1-1/4"	SS316	BSP/NPT-(M/F)/FLANGED/ SOCKET WELD	3000
	40VCC 40VCA	1-1/2"	CARBON STEEL	BSP/NPT-(M/F)/FLANGED/ SOCKET WELD	2320
	40VVS4C 40VVS4A	1-1/2"	SS304	BSP/NPT-(M/F)/FLANGED/ SOCKET WELD	2320
	40VBC 40VBBA	1-1/2"	BRASS	BSP/NPT-(M/F)/FLANGED/ SOCKET WELD	2320
	40VVS6C 40VVS6A	1-1/2"	SS316	BSP/NPT-(M/F)/FLANGED/ SOCKET WELD	2320
	50VCC 50VCA	2"	CARBON STEEL	BSP/NPT-(M/F)/FLANGED/ SOCKET WELD	1450
	50VVS4C 50VVS4A	2"	SS304	BSP/NPT-(M/F)/FLANGED/ SOCKET WELD	1450
	50VBC 50VBBA	2"	BRASS	BSP/NPT-(M/F)/FLANGED/ SOCKET WELD	1450
50VVS6C 50VVS6A	2"	SS316	BSP/NPT-(M/F)/FLANGED/ SOCKET WELD	1450	

ООО «ТИ-СИСТЕМС» ИНЖИНИРИНГ И ПОСТАВКА ТЕХНОЛОГИЧЕСКОГО ОБОРУДОВАНИЯ

Интернет: www.tisys.ru www.tisys.kz www.tisys.by www.tesec.ru www.ti-sistems.pф

Телефоны: +7 (495) 7774788, 7489626, (925) 5007155, 54, 65

Эл. почта: info@tisys.ru info@tisys.kz info@tisys.by

JRE PVT LTD.

06

QUICK RELEASE COUPLINGS - V

Manufacturing Standard: In Accordance to ISO 7241:2014

IMAGE	PART NO.	SIZE	MOC	TYPE	PR. PSI
 <p>COUPLER WITH NRV</p>	6VCC 6TCA	1/4"	CARBON STEEL	BSP/NPT-(M/F)/FLANGED/ SOCKET WELD	500
	6VS4C 6TS4A	1/4"	SS304	BSP/NPT-(M/F)/FLANGED/ SOCKET WELD	500
	6VBC 6TBA	1/4"	BRASS	BSP/NPT-(M/F)/FLANGED/ SOCKET WELD	500
	6VS6C 6TS6A	1/4"	SS316	BSP/NPT-(M/F)/FLANGED/ SOCKET WELD	500
 <p>ADAPTOR WITHOUT NRV</p>	10VCC 10TCA	3/8"	CARBON STEEL	BSP/NPT-(M/F)/FLANGED/ SOCKET WELD	500
	10VS4C 10TS4A	3/8"	SS304	BSP/NPT-(M/F)/FLANGED/ SOCKET WELD	500
	10VBC 10TBA	3/8"	BRASS	BSP/NPT-(M/F)/FLANGED/ SOCKET WELD	500
	10VS6C 10TS6A	3/8"	SS316	BSP/NPT-(M/F)/FLANGED/ SOCKET WELD	500
 <p>ASSEMBLY V TYPE</p>	12VCC 12TCA	1/2"	CARBON STEEL	BSP/NPT-(M/F)/FLANGED/ SOCKET WELD	500
	12VS4C 12TS4A	1/2"	SS304	BSP/NPT-(M/F)/FLANGED/ SOCKET WELD	500
	12VBC 12TBA	1/2"	BRASS	BSP/NPT-(M/F)/FLANGED/ SOCKET WELD	500
	12VS6C 12TS6A	1/2"	SS316	BSP/NPT-(M/F)/FLANGED/ SOCKET WELD	500

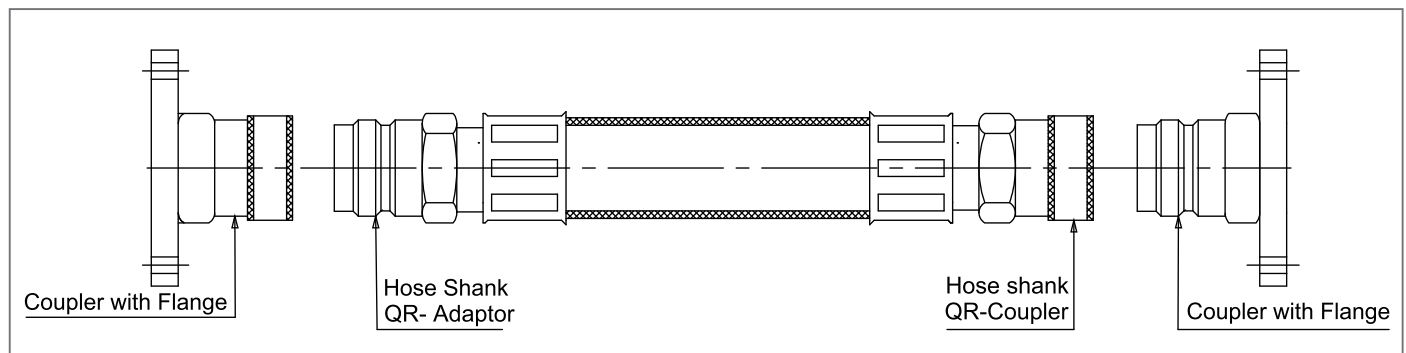

ООО «ТИ-СИСТЕМС» ИНЖИНИРИНГ И ПОСТАВКА ТЕХНОЛОГИЧЕСКОГО ОБОРУДОВАНИЯ

Интернет: www.tisys.ru www.tisys.kz www.tisys.by www.tesec.ru www.ti-sistems.pф

Телефоны: +7 (495) 7774788, 7489626, (925) 5007155, 54, 65

Эл. почта: info@tisys.ru info@tisys.kz info@tisys.by

QUICK RELEASE COUPLINGS - V

Manufacturing Standard: In Accordance to ISO 7241:2014

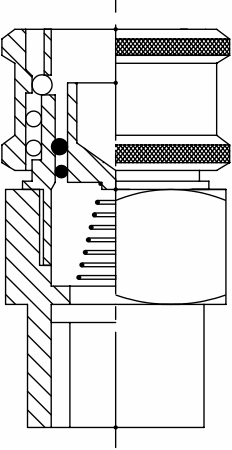
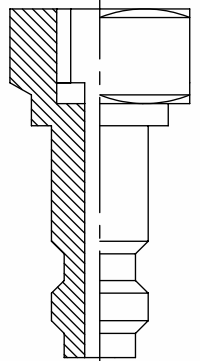
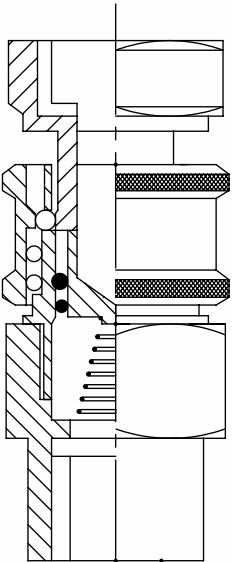
IMAGE	PART NO.	SIZE	MOC	TYPE	PR. PSI
 <p>COUPLER WITH NRV</p>	20VCC 20TCA	3/4"	CARBON STEEL	BSP/NPT-(M/F)/FLANGED/ SOCKET WELD	500
	20VS4C 20TS4A	3/4"	SS304	BSP/NPT-(M/F)/FLANGED/ SOCKET WELD	500
	20VBC 20TBA	3/4"	BRASS	BSP/NPT-(M/F)/FLANGED/ SOCKET WELD	500
	20VS6C 20TS6A	3/4"	SS316	BSP/NPT-(M/F)/FLANGED/ SOCKET WELD	500
	25VCC 25TCA	1"	CARBON STEEL	BSP/NPT-(M/F)/FLANGED/ SOCKET WELD	500
	25VS4C 25TS4A	1"	SS304	BSP/NPT-(M/F)/FLANGED/ SOCKET WELD	500
 <p>ADAPTOR WITHOUT NRV</p>	25VBC 25TBA	1"	BRASS	BSP/NPT-(M/F)/FLANGED/ SOCKET WELD	500
	25VS6C 25TS6A	1"	SS316	BSP/NPT-(M/F)/FLANGED/ SOCKET WELD	500
	32VCC 32TCA	1-1/4"	CARBON STEEL	BSP/NPT-(M/F)/FLANGED/ SOCKET WELD	300
	32VS4C 32TS4A	1-1/4"	SS304	BSP/NPT-(M/F)/FLANGED/ SOCKET WELD	300
	32VBC 32TBA	1-1/4"	BRASS	BSP/NPT-(M/F)/FLANGED/ SOCKET WELD	300
	32VS6C 32TS6A	1-1/4"	SS316	BSP/NPT-(M/F)/FLANGED/ SOCKET WELD	300
 <p>ASSEMBLY V TYPE</p>	40VCC 40TCA	1-1/2"	CARBON STEEL	BSP/NPT-(M/F)/FLANGED/ SOCKET WELD	300
	40VS4C 40TS4A	1-1/2"	SS304	BSP/NPT-(M/F)/FLANGED/ SOCKET WELD	300
	40VBC 40TBA	1-1/2"	BRASS	BSP/NPT-(M/F)/FLANGED/ SOCKET WELD	300
	40VS6C 40TS6A	1-1/2"	SS316	BSP/NPT-(M/F)/FLANGED/ SOCKET WELD	300
	50VCC 50TCA	2"	CARBON STEEL	BSP/NPT-(M/F)/FLANGED/ SOCKET WELD	300
	50VS4C 50TS4A	2"	SS304	BSP/NPT-(M/F)/FLANGED/ SOCKET WELD	300
	50VBC 50TBA	2"	BRASS	BSP/NPT-(M/F)/FLANGED/ SOCKET WELD	300
	50VS6C 50TS6A	2"	SS316	BSP/NPT-(M/F)/FLANGED/ SOCKET WELD	300

ООО «ТИ-СИСТЕМС» ИНЖИНИРИНГ И ПОСТАВКА ТЕХНОЛОГИЧЕСКОГО ОБОРУДОВАНИЯ

Интернет: www.tisys.ru www.tisys.kz www.tisys.by www.tesec.ru www.ti-sistems.pф

Телефоны: +7 (495) 7774788, 7489626, (925) 5007155, 54, 65

Эл. почта: info@tisys.ru info@tisys.kz info@tisys.by

JRE PVT LTD.

08

QUICK RELEASE COUPLINGS - T

Manufacturing Standard: In Accordance to ISO 7241:2014

IMAGE	PART NO.	SIZE	MOC	TYPE	PR. PSI
 <p>COUPLER WITHOUT NRV</p>	6TCC 6TCA	1/4"	CARBON STEEL	BSP/NPT-(M/F)/FLANGED/ SOCKET WELD	1000
	6TS4C 6TS4A	1/4"	SS304	BSP/NPT-(M/F)/FLANGED/ SOCKET WELD	1000
	6TBC 6TBA	1/4"	BRASS	BSP/NPT-(M/F)/FLANGED/ SOCKET WELD	1000
	6TS6C 6TS6A	1/4"	SS316	BSP/NPT-(M/F)/FLANGED/ SOCKET WELD	1000
 <p>ADAPTOR WITHOUT NRV</p>	10TCC 10TCA	3/8"	CARBON STEEL	BSP/NPT-(M/F)/FLANGED/ SOCKET WELD	1000
	10TS4C 10TS4A	3/8"	SS304	BSP/NPT-(M/F)/FLANGED/ SOCKET WELD	1000
	10TBC 10TBA	3/8"	BRASS	BSP/NPT-(M/F)/FLANGED/ SOCKET WELD	1000
	10TS6C 10TS6A	3/8"	SS316	BSP/NPT-(M/F)/FLANGED/ SOCKET WELD	1000
 <p>ASSEMBLY T TYPE</p>	12TCC 12TCA	1/2"	CARBON STEEL	BSP/NPT-(M/F)/FLANGED/ SOCKET WELD	1000
	12TS4C 12TS4A	1/2"	SS304	BSP/NPT-(M/F)/FLANGED/ SOCKET WELD	1000
	12TBC 12TBA	1/2"	BRASS	BSP/NPT-(M/F)/FLANGED/ SOCKET WELD	1000
	12TS6C 12TS6A	1/2"	SS316	BSP/NPT-(M/F)/FLANGED/ SOCKET WELD	1000

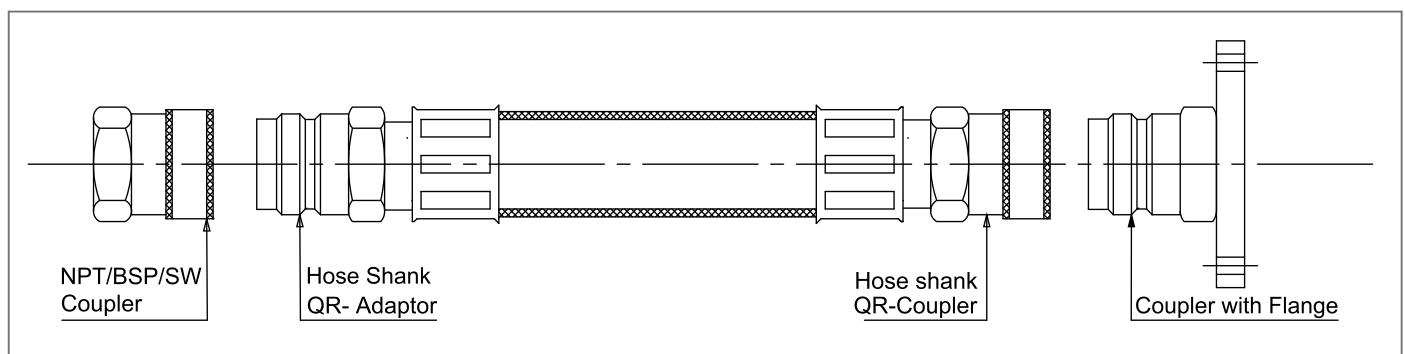

ООО «ТИ-СИСТЕМС» ИНЖИНИРИНГ И ПОСТАВКА ТЕХНОЛОГИЧЕСКОГО ОБОРУДОВАНИЯ

Интернет: www.tisys.ru www.tisys.kz www.tisys.by www.tesec.ru www.ти-системс.рф

Телефоны: +7 (495) 7774788, 7489626, (925) 5007155, 54, 65

Эл. почта: info@tisys.ru info@tisys.kz info@tisys.by

QUICK RELEASE COUPLINGS - T

Manufacturing Standard: In Accordance to ISO 7241:2014

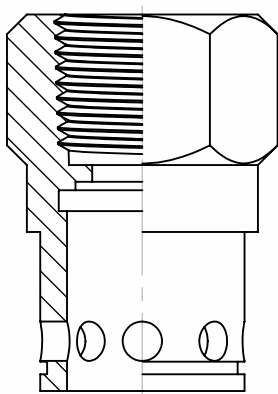
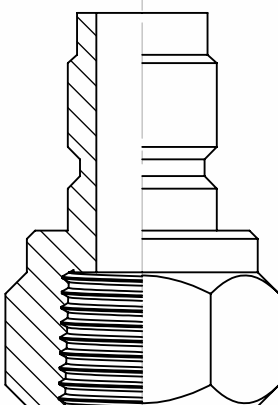
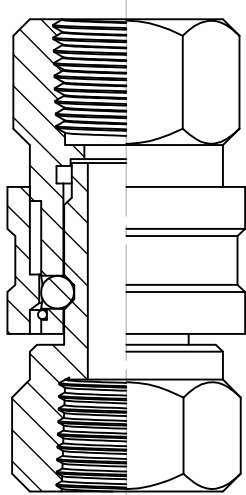
IMAGE	PART NO.	SIZE	MOC	TYPE	PR. PSI
 <p>Coupler without NRV</p>	20TCC 20TCA	3/4"	CARBON STEEL	BSP/NPT-(M/F)/FLANGED/ SOCKET WELD	1000
	20TS4C 20TS4A	3/4"	SS304	BSP/NPT-(M/F)/FLANGED/ SOCKET WELD	1000
	20TBC 20TBA	3/4"	BRASS	BSP/NPT-(M/F)/FLANGED/ SOCKET WELD	1000
	20TS6C 20TS6A	3/4"	SS316	BSP/NPT-(M/F)/FLANGED/ SOCKET WELD	1000
	25TCC 25TCA	1"	CARBON STEEL	BSP/NPT-(M/F)/FLANGED/ SOCKET WELD	1000
	25TS4C 25TS4A	1"	SS304	BSP/NPT-(M/F)/FLANGED/ SOCKET WELD	1000
 <p>Adaptor without NRV</p>	25TBC 25TBA	1"	BRASS	BSP/NPT-(M/F)/FLANGED/ SOCKET WELD	1000
	25TS6C 25TS6A	1"	SS316	BSP/NPT-(M/F)/FLANGED/ SOCKET WELD	1000
	32TCC 32TCA	1-1/4"	CARBON STEEL	BSP/NPT-(M/F)/FLANGED/ SOCKET WELD	1000
	32TS4C 32TS4A	1-1/4"	SS304	BSP/NPT-(M/F)/FLANGED/ SOCKET WELD	1000
	32TBC 32TBA	1-1/4"	BRASS	BSP/NPT-(M/F)/FLANGED/ SOCKET WELD	1000
	32TS6C 32TS6A	1-1/4"	SS316	BSP/NPT-(M/F)/FLANGED/ SOCKET WELD	1000
 <p>Assembly T Type</p>	40TCC 40TCA	1-1/2"	CARBON STEEL	BSP/NPT-(M/F)/FLANGED/ SOCKET WELD	500
	40TS4C 40TS4A	1-1/2"	SS304	BSP/NPT-(M/F)/FLANGED/ SOCKET WELD	500
	40TBC 40TBA	1-1/2"	BRASS	BSP/NPT-(M/F)/FLANGED/ SOCKET WELD	500
	40TS6C 40TS6A	1-1/2"	SS316	BSP/NPT-(M/F)/FLANGED/ SOCKET WELD	500
	50TCC 50TCA	2"	CARBON STEEL	BSP/NPT-(M/F)/FLANGED/ SOCKET WELD	500
	50TS4C 50TS4A	2"	SS304	BSP/NPT-(M/F)/FLANGED/ SOCKET WELD	500
	50TBC 50TBA	2"	BRASS	BSP/NPT-(M/F)/FLANGED/ SOCKET WELD	500
	50TS6C 50TS6A	2"	SS316	BSP/NPT-(M/F)/FLANGED/ SOCKET WELD	500

ООО «ТИ-СИСТЕМС» ИНЖИНИРИНГ И ПОСТАВКА ТЕХНОЛОГИЧЕСКОГО ОБОРУДОВАНИЯ

Интернет: www.tisys.ru www.tisys.kz www.tisys.by www.tesec.ru www.ti-sistems.pф

Телефоны: +7 (495) 7774788, 7489626, (925) 5007155, 54, 65

Эл. почта: info@tisys.ru info@tisys.kz info@tisys.by

JRE PVT LTD.

HOSE FITTINGS

COMPOSITE HOSE FITTINGS

MOC: CS/SS/Brass

Dimensions: As per Client Drawings

DESCRIPTION	SIZE	PART NO.	DESCRIPTION	SIZE	PART NO.
 CAMLOCK FEMALE	3/4"-2"	JCHFF	 FIX FLANGE	3/4"-10"	JCHFF
 CAMLOCK MALE	3/4"-6"	JCHFCM	 SWIVEL FLANGE	3/4"-10"	JCHFSF
 CAMLOCK FEMALE	3/4"-6"	JCHFCF	 FERRULE	3/4"-10"	JCHFF
 MALE THREAD HEXAGONAL	3/4"-3"	JCHFM	 LUG NUT	1-1/2"-4"	JCHFLN

ООО «ТИ-СИСТЕМС» ИНЖИНИРИНГ И ПОСТАВКА ТЕХНОЛОГИЧЕСКОГО ОБОРУДОВАНИЯ

Интернет: www.tisys.ru www.tisys.kz www.tisys.by www.tesec.ru www.ti-sistemc.pф













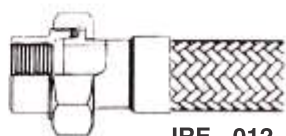

Телефоны: +7 (495) 7774788, 7489626, (925) 5007155, 54, 65

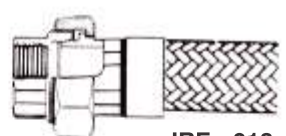
Эл. почта: info@tisys.ru info@tisys.kz info@tisys.by

STANDARD FITTINGS

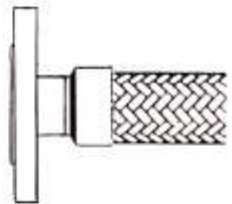
STANDARD EXECUTIONS FOR JRE ANNULAR CORRUGATED S.S. HOSE &* TEFLON HOSE

The fitting are available in M.S., C.S., S.S., Brass, G.M., Rolled bronze. Flange connection with fixed & floating flanges meet to IS, Din, ANSI * ASA standards or as per customer's specifications.

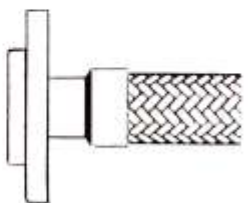
	WELDING END	HEXAGON UNION WELDING END	
JRE - 001			JRE - 010
	PIPE NIPPLE TAPERED MALE	HEXAGON UNION STRAIGHT FEMALE	
JRE - 002			JRE - 011
	HEXAGON NIPPLE TAPERED MALE	STAINLESS STEEL HEXAGON UNION STRAIGHT FEMALE	
JRE - 003			JRE - 012
	HEXAGON NIPPLE STRAIGHT MALE	HEXAGON UNION GF 304 TYPE STRAIGHT FEMALE	
JRE - 004			JRE - 013
	PLAIN SOCKET STRAIGHT FEMALE	3000 LBS HEAVY DUTY TYPE STRAIGHT FEMALE	
JRE - 005			JRE - 014
	HEXAGON SOCKET STRAIGHT FEMALE	FIXED FLANGE	
JRE - 006			JRE - 015
	FEMALE SWIVEL		
JRE - 007			
	HEXAGON UNION STRAIGHT FEMALE		
JRE - 008			
	Hexagon union Straight male	FLOATING FLAMGE	
JRE - 009			JRE - 016

JRE standard, fitting seat = FLAT SEAT, or as per customers specification, only if specified.



OTHER PRODUCTS CATALOGUE AVAILABLE ON REQUEST

Composite Hose

Rubber Hose

Stainless Steel Hose

PTFE Hose

Cryogenic Hose

Food Grade Hose

Transparent Hose

Fire Resistant Hose

LPG/LNG Hose

Specialised Bellows

Dry Break Couplings

Break Away Couplings

Driplex Coupling

Smart Online Particle Size Analyzers

Pipe Repair Clamps



ISO 9001 : 2015
ISO 14001 : 2015
OHSAS 18001 : 2007